

Refrigerators and freezers  
**Biomedical**  
2019

Quality, Design and Innovation



**LIEBHERR**

# Contents



Superior Performance Refrigerators and Freezers \_\_\_\_\_ 14



Vaccine & Laboratory Refrigerators \_\_\_\_\_ 20

- Quality, Design and Innovation \_\_\_\_\_ 5
- Best practice in manufacture \_\_\_\_\_ 6
- Save energy and act sustainably \_\_\_\_\_ 7
- Superior performance and safety for your peace of mind \_\_\_\_\_ 8
- Customer service and support \_\_\_\_\_ 9
- Good reasons to choose Liebherr \_\_\_\_\_ 10
- Biomedical Refrigerators and Freezers \_\_\_\_\_ 12
  - Superior Performance Refrigerators and Freezers \_\_\_\_\_ 14
  - Vaccine & Laboratory Refrigerators \_\_\_\_\_ 20
  - Spark-free Laboratory Refrigerators and Freezers \_\_\_\_\_ 26
  - Spark-free Laboratory Refrigerators with mechanical (dial) control \_\_\_\_\_ 32
  - Low Temperature Chest Freezers \_\_\_\_\_ 36
- Accessories \_\_\_\_\_ 43



# Quality, Design and Innovation

As a specialist for fridges and freezers, Liebherr offers an extensive range of robust special appliances for commercial use. The unique quality, timeless design and innovation that characterise our products are expressions of our many years of experience in the manufacture of modern fridges. Every day, Liebherr appliances allow our customers to experience and benefit from the expertise we have developed over decades in the commercial field.

## Quality

For more than 60 years, the name Liebherr has stood for high-quality and innovative fridges and freezers. Our focus, from the product conception to development and production through to marketing, is on offering innovative top-quality products. In the process, we consistently implement new product ideas for the perfect and safe storage of foods and of sensitive samples, medication or research materials in laboratory use. In the process, we consistently implement new product ideas for the safe and secure storage of valuable samples and reagents, chemicals, medicines and vaccines. We conduct checks as early as the development stage to ensure that all refrigeration, mechanical and electronic components function dependably and over the long term, and we also make sure that optimal operability and operational reliability of appliances is guaranteed. For example, in the quality test, door hinges must complete at least 100,000 opening cycles - equivalent to usage of over 15 years. A visual inspection of processing quality also occurs. This helps us to ensure the optimal compatibility of all components with one another: for maximum functionality and efficiency.

## Design

Liebherr appliances for professional use are characterised by a specific combination of aesthetics and functionality. With their elegant and timeless design, the fridges and freezers meet the highest aesthetic standards. The high-quality look of our commercial appliances shows itself in many details: from stainless steel processing to a selection of high-quality materials and to the interior features. Thanks to their consistent design, our professional appliances can be easily combined and also really catch the eye.

## Innovation

The constant development of our high-quality products is particularly important to us. That is why all Liebherr production sites have development centres with modern equipment and highly qualified employees. We invest in research and development because only then can we truly offer our customers top quality in the long term, while simultaneously meeting our own high standards. Our aim is to be "best in class" in every aspect. Innovations, whether in refrigeration technology, convenience or safety, have always been an important and supporting pillar in our history and will remain so in future as well. With great dedication and passion we work hard to incorporate innovations into our appliances in order to set new standards in the field of professional fridges and freezers. Last but not least, our appliances for commercial use are highly efficient thanks to state-of-the-art electronics combined with optimised cooling circuits, so they make a considerable contribution towards economic and ecological sustainability.

# Best practice in manufacture

A great deal of know-how, development work and love of detail is invested in every single Liebherr appliance. Before an appliance goes into series production, engineers have completed months of research and development to ensure that a high quality product is created which meets all the requirements of professional use.

As a premium manufacturer we have something essential in common with our customers: we set the highest possible standards for our appliances and components. The quality of Liebherr appliances is a solid foundation for the high level of trust that customers have in the Liebherr brand. At our production locations, we are working constantly on the further development and optimisation of all appliance components and materials. Our professional appliances and components undergo continuous quality monitoring throughout the entire production process. In order to guarantee these high standards of quality, we subject

all components to extreme loads in extensive and practical testing. In doing so, we ensure that only the highest quality appliances, which fully meet the particular requirements for commercial use, leave our production locations. Our highly-qualified and well-trained employees are also a central factor here. Thanks to their dedication and commitment, Liebherr continues to set high standards and guarantee outstanding quality. No wonder then that customers around the world are impressed by the durability of our fridges and freezers.



Symbol picture

# Save energy and act sustainably

As a family business operating globally, Liebherr bears great responsibility towards society, the environment, customers, employees and suppliers. Going beyond regulations and legislation, the environmental effects of products and production sites are reduced and kept to a minimum. This is why a responsible and sustainable approach to energy is especially important to Liebherr in all development processes.

Energy efficiency has always been a central issue for Liebherr, and it has a decisive effect even during the design of fridges and freezers for professional use. High-quality components allow the appliances to provide excellent cooling. Tailored for professional use, these components also help lower electricity costs. With our products, the concept of protecting the environment is taken into account throughout the life cycle. Liebherr was the first company to convert its entire range of professional fridges and freezers to CFC-free and HFC-free refrigerants. Since then we have been using the natural and environmentally friendly refrigerants R 290 and R 600a. In combination with powerful compressors and modern cooling components, they ensure that our appliances for professional use are particularly energy-efficient and economical.

The plastics we use are all labelled for optimum recycling, and our production processes are also arranged for efficient resource use. Throughout the entire production process, any generated heat is recovered as heating energy. At an early stage, suppliers and service providers are integrated into the current quality and sustainability standards. Our integrated management system serves to fulfil these requirements and to achieve the objectives sought. Its effectiveness is regularly checked by audits. All Liebherr production sites are certified according to the international standards for quality ISO 9001 and environmental management ISO 14001.



# Superior performance and safety for your peace-of-mind

The superior performance, safety features and reliability of Liebherr biomedical fridges and freezers makes them the ideal choice for laboratories, pharmacies, hospitals, diagnostic and healthcare facilities.

Liebherr biomedical refrigerators and freezers are designed to EN 60068-3 for optimal temperature stability and consistency. The forced-air cooling system ensures temperature uniformity within each unit and fast temperature recovery after door openings.

LKPv, LGPv and LGv models use an innovative short hot gas defrost cycle which allows the units to defrost more often and faster without compromising temperature control and integrity of stored contents.

When it comes to safety, visual and audible alarms warn users of temperature breaches, an integrated data memory in the electronic controller logs temperature and alarm events, keypad lock prevents temperature and alarm setting changes without passcode, and a physical lock protects against unauthorised access.

Connecting to remote monitoring and building management systems can also be facilitated using RS 485 interface, volt-free alarm contact or by integration of an independent temperature sensor via access port.



# Customer service and support

As a manufacturer of high-quality biomedical fridges and freezers, Liebherr strives to provide its customers with the highest level of ongoing service and support for the life of the product.

Your satisfaction is central to all that we do, and Liebherr works with trusted partners to provide our customers with local service and support, 24 hours a day, 365 days a year. All incoming questions, whether asked in writing or in person, are recorded and attended to swiftly by our highly experienced customer service team. Our aim is to provide you with a prompt response and best possible solution. We also pride ourselves on having spare parts available locally to avoid lengthy delays and unnecessary downtime, plus hold spare parts for up to 10 years after manufacture.

Every Liebherr biomedical fridges and freezers is made with high-quality materials and components, and is factory tested for functionality and durability. Our continued focus on product development means we are always working to improve our appliances to meet the changing needs of our customers.



# Good reasons to choose Liebherr



## Superior Performance

Liebherr biomedical refrigerators and freezers are equipped with precise electronic controls that allows temperature to be set to 1/10°C accuracy and have an in-built temperature calibration function for precise temperature control. Full cooling capacity is achieved by the forced-air cooling system working in conjunction with the highly efficient compressor, effective insulation and double ventilation. LKPv, LGPv and LGv models use an innovative short hot gas defrost cycle which allows the units to defrost less often and faster without compromising temperature control and integrity of the contents.

## Energy Efficient

Liebherr biomedical refrigerators and freezers use eco-friendly natural refrigerants and working with the forced-air cooling system and thick insulation guarantees low operating costs while being good for the environment.

## Reliability

German engineered and manufactured with high-quality materials, Liebherr biomedical refrigerators and freezers are robust and durable to guarantee long life. Each unit is designed to EN 60068-3 for maximum temperature stability and reliable operation.

## Easy cleaning

Moulded inner liners and high-quality seals prevents dirt and dust build up to make Liebherr biomedical refrigerators and freezers low maintenance and easy to clean. Castors, roller sets and adjustable legs allow units to be moved for cleaning of surfaces beneath the unit.

## Safety

Liebherr biomedical refrigerators and freezers are equipped with a data memory that logs and stores temperature and alarm events for 41 days. Audible and visual alarms alert users of temperature breaches, power failure and when door is ajar after 1 minute, and these alarms can be forwarded to remote monitoring systems using volt-free alarm contact. An RS 485 interface allows 20 units to networked, and temperature data and alarms to be sent to building management systems. In the event of a power failure, the electronic controller of the LKPv and LGv models has a battery back-up for 72 hours to monitor internal temperature. Self-closing doors at less than 60° prevent thermal loss, physical locks protect against unauthorised access and keypad lock prevents temperature and alarm setting changes without passcode for extra security.

## Service

Liebherr works with trusted partners to provide our customers with local service and support, 24 hours a day, 365 days a year, and access to spare parts. The refrigeration components for the LKPv and LGPv models are top-mounted and securely integrated in the ceiling area of the appliance for easy access and to service. While the refrigeration components for the LKv, LKUv, LGex, LGUex and LKexv models are accessible from the rear of the appliance.



## Biomedical Refrigerators and Freezers

Liebherr biomedical refrigerators and freezers are purpose-built for use in laboratories, pharmacies, hospitals, diagnostic and healthcare facilities. Our appliances are equipped with functions and features to optimise storage of temperature-sensitive biological samples and reagents, vaccines, medicines and chemicals. Precise temperature setting of the electronic controller and the forced-air cooling system create an optimal storage environment, and alarms alert users of temperature breaches to give you peace-of-mind and provide safety that is essential in any laboratory - 24 hours a day, 365 days each year.

# The advantages at a glance



Refrigeration components are top mounted and securely integrated in the ceiling of the appliance for easy access and to service.



The electronic controller has an **integrated data memory** to log and store min./max. temperature and last 3 alarm events for 41 days.



A 7.0mm **access port** in the ceiling of the unit allows the integration of an independent temperature sensor.

In the event of a power failure, the electronic controller of the LKPv and LGv models has a **72-hour battery back-up** to monitor internal temperature.



The interior is made of **304-grade stainless steel** for easy cleaning and optimum hygiene.

To increase the **net capacity** of the inner liner, functional parts like fans and evaporators are located **outside** the refrigerator compartment to save space.



**Self-closing door** at less than 60° for user convenience.



Temperature can be set to **1/10°C accuracy** using the electronic controller. Fridges are factory set to +5°C while freezers at -20°C.



After a refrigerator or freezer door has been opened, a **vacuum** is built up by **air exchange** – with the effect that the door is hard to reopen immediately afterwards. The **integrated pressure relief valve** ensures that the vacuum is quickly equalised so that the door can easily be reopened.

Alarms can be forwarded to remote monitoring systems using **volt-free alarm contact**, and **RS 485 interface** allows 20 units to networked, and temperature data and alarms to be sent to building management systems.

Maximum temperature stability is achieved by the **forced-air cooling system** working in conjunction with the **highly efficient compressor, effective insulation** and **double ventilation**.

**Audible and visual alarms** alert users to temperature breaches, power failure and when door is ajar for more than 1 minute.



An innovative **hot-gas defrost cycle** allows the units to defrost less often and faster. Refrigerators defrost in 8 minutes and freezers in 12 minutes without compromising temperature and integrity of the contents.

**1-point temperature calibration function** allows precise temperature control when an independent temperature sensor is connected to electronic controller.

Castors allow easy movement for cleaning and re-positioning of unit.



LKPv 6520



# Quality right down to the smallest detail

The quality, design and innovation of the superior performance refrigerators and freezers guarantees the safe and effective storage of valuable samples and reagents.



**Electronic controller with digital display.**

The electronic controller allows users to set temperature to 1/10°C accuracy using the membrane keypad and digital display.

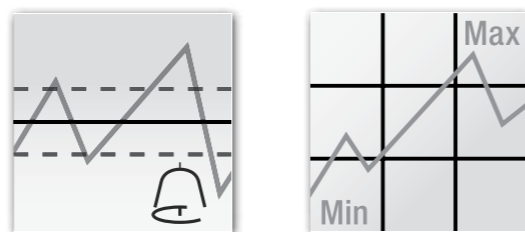

**Integrated alarm system.**

Audible and visual alarms alert users of temperature breaches, power failure and when door is ajar for more than 1 minute.

**Integrated data memory.**

The integrated data memory in the electronic controller logs and stores min./max temperature and last 3 alarm events for 41 days.

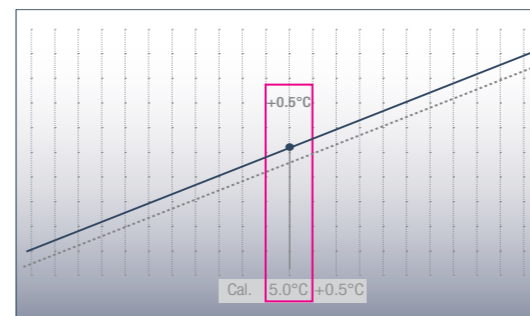

**Accurate 1-point calibration.**

1-point temperature calibration function permits compensation between the set temperature and actual internal temperature when using an independent sensor for accurate temperature control.



**Mains-independent power supply of the electronic controller.**

In case of power failure, the electronic controller is powered by a battery. The memory continues to log the internal temperature for another 72 hours. If external alarm and monitoring systems have been connected, then data transfer to these is also maintained.



**External temperature and alarm documentation.**

Alarms can be forwarded to remote monitoring systems using volt-free alarm contact, and RS 485 interface allows 20 units to be networked with temperature data and sent to building management systems.

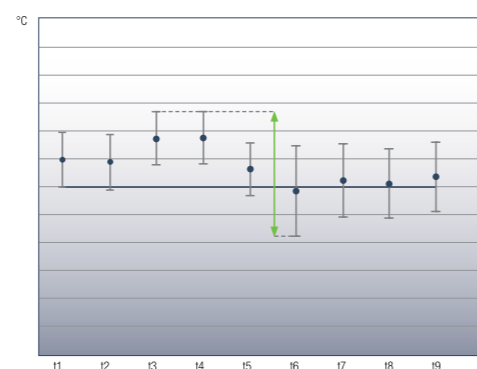

**Maximum temperature consistency.**

The forced air cooling system ensures temperature uniformity within each unit and fast temperature recovery after door openings. Liebherr biomedical refrigerators and freezers are designed to EN 60068-3 for optimal temperature stability and consistency.

**Advantage of hot gas defrost**

It is quick, with minimal temperature rise.

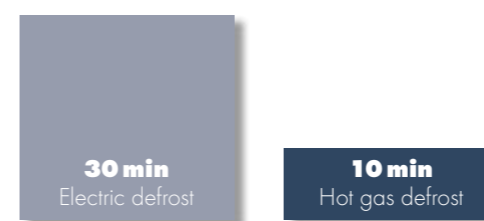

**Hot-gas defrost cycle.**

An innovative hot-gas defrost cycle allows the units to defrost less often and faster. Refrigerators defrost in 8 minutes and freezers in 12 minutes without compromising temperature and integrity of contents. Before defrosting, the internal temperature is slightly lowered so that temperature remains almost constant during the cycle.



**Versatile interior.**

The U-shaped tray slides are height adjustable and allow users to configure the plastic-coated grid shelves to maximize their storage capacity. Shelf loading capacity is 60kg. The interior is made of 304-grade stainless steel for easy cleaning and optimum hygiene.



**Superior Performance Refrigerators & Freezers**

	<b>LKpv 1423</b> MediLine	<b>LKpv 6523</b> MediLine	<b>LKpv 6520</b> MediLine	<b>LGPv 1420</b> MediLine	<b>LGPv 6520</b> MediLine	<b>LGv 5010</b> MediLine
<b>Gross capacity</b>	1361 litre	597 litre	597 litre	1361 litre	597 litre	478/337 litre
<b>Exterior dimensions in mm (w/d/h)</b>	1430/830/2160	700/830/2160	700/830/2160	1430/830/2160	700/830/2160	747/750/1844
<b>Interior dimensions in mm (w/d/h)</b>	1236/650/1500	533/650/1500	533/650/1550	1236/650/1550	533/650/1550	602/520/1224
<b>Energy consumption in 365 days <sup>1</sup></b>	820 kWh	571 kWh	497 kWh	2654 kWh	1367 kWh	1245 kWh
<b>Ambient temperature range</b>	+10°C to +40°C	+10°C to +40°C	+10°C to +40°C	+10°C to +40°C	+10°C to +40°C	+16°C to +35°C
<b>Refrigerant</b>	R 290	R 290	R 290	R 290	R 290	R 290
<b>Sound power level</b>	58 dB(A)	58 dB(A)	58 dB(A)	60 dB(A)	60 dB(A)	55 dB(A)
<b>Voltage/Connection rating</b>	220–240V~/3.0 A	220–240V~/2.0 A	220–240V~/2.0 A	220–240V~/4.5 A	220–240V~/4.0 A	220–240V~/3.0 A
<b>Cooling system/Defrost</b>	forced-air / automatic	forced-air / automatic	forced-air / automatic	forced-air / automatic	forced-air / automatic	forced-air
<b>Temperature range</b>	0°C to +16°C	0°C to +16°C	-2°C to +16°C	-9°C to -26°C	-9°C to -35°C <sup>2</sup>	automatic
<b>Gradient*/max. fluctuation**</b>	3.8°C/3.9°C	2.0°C/1.6°C	1.8°C/1.0°C	4.3°C/6.7°C	2.9°C/3.6°C	-9°C to -35°C
<b>External cabinet finish</b>	steel/white	steel/white	steel/white	steel/white	steel/white	5.8°C/4.9°C
<b>Door/lid material</b>	glass door	glass door	steel	steel	steel	steel/white
<b>Internal liner material</b>	304-grade stainless steel	304-grade stainless steel	304-grade stainless steel	304-grade stainless steel	304-grade stainless steel	commercial grade moulded polystyrol
<b>Type of control</b>	electronic controller	electronic controller	electronic controller	electronic controller	electronic controller	electronic controller
<b>Temperature display</b>	external digital	external digital	external digital	external digital	external digital	external digital
<b>Power failure alarm</b>	immediately upon power failure for 72hrs	immediately upon power failure for 72hrs	immediately upon power failure for 72hrs	immediately upon power failure for 72hrs	immediately upon power failure for 72hrs	when mains power return
<b>Fault: warning signal</b>	visual and audible	visual and audible	visual and audible	visual and audible	visual and audible	visual and audible
<b>Interface/Volt-free alarm contact</b>	RS 485/yes	RS 485/yes	RS 485/yes	RS 485/yes	RS 485/yes	RS 485/yes
<b>Interior light</b>	LED lighting, with separate switch	LED lighting, with separate switch				
<b>Adjustable shelves</b>	8	4	4	8	4	5
<b>Usable shelf area in mm (w/d)</b>	1236/640	533/650	533/650	1236/640	533/650	602/485
<b>Shelf material</b>	wire shelves plastic-coated	wire shelves plastic-coated	wire shelves plastic-coated	wire shelves plastic-coated	wire shelves plastic-coated	wire shelves plastic-coated
<b>Shelf loading</b>	60 kg	60 kg	60 kg	60 kg	60 kg	60 kg
<b>No. of drawers/baskets</b>	–	–	–	–	–	8/2
<b>Castors</b>	castors with brake at the front, castors at the rear	castors with brake at the front, fixed castors at the rear	castors with brake at the front, fixed castors at the rear	castors with brake at the front, castors at the rear	castors with brake at the front, fixed castors at the rear	
<b>Handle</b>	full-length integrated handle	full-length integrated handle	full-length integrated handle	full-length integrated handle	full-length integrated handle	ergonomic slimline handle
<b>Lock</b>	fitted	fitted	fitted	fitted	fitted	fitted
<b>Self-closing door</b>	yes	yes	yes	yes	yes	yes
<b>Door hinges</b>	left hand/ right hand	right, reversible on site	right, reversible on site	left hand/ right hand	right, reversible on site	right, reversible on site
<b>Gross/net weight</b>	265/228 kg	163/136 kg	152/126 kg	253/207 kg	160/133 kg	124/114 kg
<b>Accessories</b>	7112393	7112393	7112393	7112393	7112393	7112059
Shelf, plastic-coated	9001761	9001761	9001761	9001761	9001761	
U-shaped trayslide, right	9001757	9001757	9001757	9001757	9001757	
U-shaped trayslide, left	9590639	9590659	9590659	9590639	9590659	
Foot pedal opener	9590387	9590387	9590387	9590387	9590387	9094502
RS 485/RS 232 adapter, data log software	9590407	9590407	9590407	9590407	9590407	9590387
NTC product temperature sensor	9901947	9901947	9901947	9901947	9901947	9591493
Side-by-Side set						

<sup>1</sup> Measured at +25°C ambient temperature and +5°C set temperature for fridges and -20°C for freezers

\* Gradient as defined in EN 60068-3: the difference between the warmest and coldest average measurements, increased by their expanded uncertainty, throughout the duration.

\*\* Max. fluctuation as per EN 60068-3: greatest fluctuation value determined throughout the duration of measurements.

# The advantages at a glance



**Audible and visual alarms** alert users to temperature breaches and when door is ajar for more than 1 minute. A visual signal will appear when mains power returns after power outage.



**Commercial grade polystyrol moulded inner liner** has channels that allow users to adjust shelf height and configuration of shelves to suit individual storage needs.



Equipped with **fully adjustable wire plastic-coated shelves** that can be removed when door is opened at 90°. Shelf loading capacity is 45kg.

**10mm access port** inside the unit allows an independent temperature sensor to be connected.



In laboratory fridge-freezer LCv4010, the **drawers** can be removed easily using the **recessed grips** integrated on the sides. The drawers have a transparent front to provide a clear view of the goods.



A **physical lock** protects against unauthorised access and **keypad lock** prevents temperature and alarm setting changes without passcode.



The **precise electronic controller** with digital temperature display allows accurate temperature setting to 1/10°C. An **integrated data memory** logs the last three temperature alarms and power failures, together with the time, date and duration of the alarm. The respective data can be recalled using the AlarmLog function and read on the display panel.



LKv 3913 and LKUv 1613 have an **interior LED light**, with separate switch on electronic controller to allow the visualisation of contents.



**1-point calibration** for accurate temperature control. This permits compensation between the set temperature and the actual internal temperature.

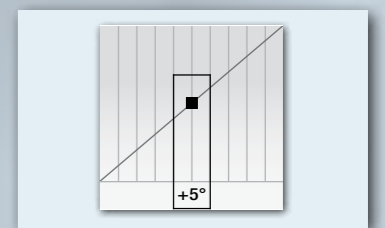

**Self-closing door** at less than 60° prevents cold loss and contributes to temperature stability.

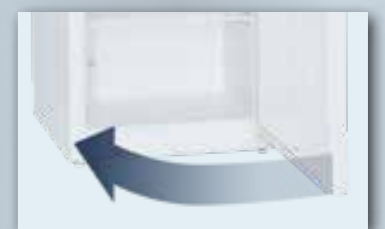

The **forced-air cooling system** working in conjunction with the **highly efficient compressor, effective insulation** and **double ventilation** ensures maximum temperature stability and consistency.

LKv 3913

# Quality right down to the smallest detail

Liebherr Vaccine & Laboratory Refrigerators are the ideal solution for pharmacies and laboratories with limited floor space. Customers can choose from upright or under-counter refrigerators with either glass or solid door. The precise electronic controller allows temperature to be set to 1/10°C accuracy, and the forced-air cooling system ensures maximum temperature stability within cabinet. Audible and visual alarms alert users to temperature breaches, when door is ajar for more than 1 minute and power outage when mains power returns.



### External temperature and alarm documentation.

Alarms can be forwarded to remote monitoring systems using volt-free alarm contact, and RS 485 interface allows temperature data and alarms to be sent to building management systems. LKv 3913, LKv 3910, LKUv 1613 and LKUv 1610 come with a data logger for independent temperature logging to comply with National Vaccine Storage Guidelines.

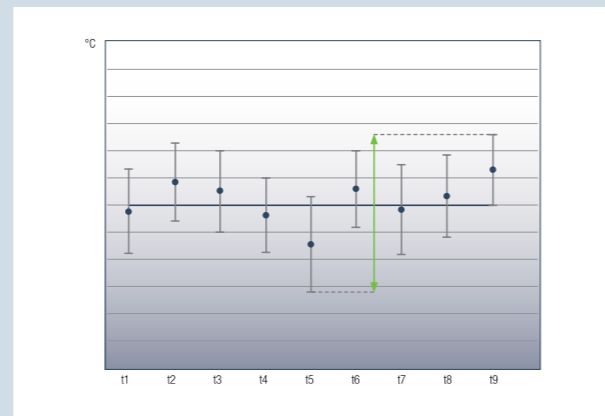

### Maximum temperature consistency.

The precise electronic controller allows temperature to be set to 1/10°C accuracy, and the forced-air cooling system working in conjunction with the highly efficient compressor, effective insulation and double ventilation provides a uniform temperature within the cabinet. Each unit is designed to EN 60068-3 for maximum temperature stability and reliable operation.

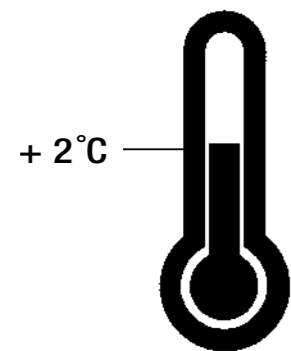

### Safety thermostat.

Alarm parameters are set as a difference of ±3°C from set temperature and can be adjusted if required by users. A safety thermostat prevents temperature dropping below +2°C to protect temperature-sensitive contents in the event of a fault. LKv 3913, LKv 3910, LKUv 1613 and LKUv 1610 are fitted with evaporator covers to protect contents from coming into contact with cooling plate and freezing.



### External temperature sensor.

10mm access port at the bottom of unit allows an independent temperature sensor to be connected from the back of the unit so temperature control is not compromised.



## Vaccine & Laboratory Refrigerators

	<b>LKv 5710</b> MediLine	<b>LKv 3913</b> MediLine	LED	<b>LKv 3910</b> MediLine
<b>Total gross/net capacity</b>	583/437 litre	386/360 litre		361/336 litre
<b>Exterior dimensions in mm (w/d/h)</b>	747/750/1844	597/615/1840		597/615/1840
<b>Interior dimensions in mm (w/d/h)</b>	634/538/1500	440/435/1635		440/435/1635
<b>Energy consumption in 365 days<sup>1</sup></b>	438 kWh	480 kWh		309 kWh
<b>Ambient temperature range</b>	+10°C to +35°C	+10°C to +35°C		+10°C to +35°C
<b>Refrigerant</b>	R 600a	R 600a		R 600a
<b>Sound power level</b>	52 dB(A)	48 dB(A)		48 dB(A)
<b>Voltage/Connection rating</b>	220–240V~/1.0 A	220–240V~/1.5 A		220–240V~/1.5 A
<b>Cooling system</b>	forced-air	forced-air		forced-air
<b>Defrost</b>	automatic	automatic		automatic
<b>Temperature range</b>	+3°C to +16°C	+3°C to +16°C		+3°C to +16°C
<b>Gradient*/max. fluctuation**</b>	3.8°C/3.1°C	5.6°C/4.7°C		4.1°C/3.6°C
<b>External cabinet finish</b>	steel/white	steel/white		steel/white
<b>Door/lid material</b>	steel	glass door		steel
<b>Internal liner material</b>	commercial grade moulded polystyrol	commercial grade moulded polystyrol		commercial grade moulded polystyrol
<b>Type of control</b>	electronic controller	electronic controller		electronic controller
<b>Temperature display</b>	external digital	external digital		external digital
<b>Power failure alarm</b>	when mains power return	when mains power return		when mains power return
<b>Fault: warning signal</b>	visual and audible	visual and audible		visual and audible
<b>Interface/Volt-free alarm contact</b>	RS 485/yes	RS 485/yes		RS 485/yes
<b>Interior light</b>		LED lighting, with separate switch		
<b>Adjustable shelves</b>	5	9		9
<b>Usable shelf area in mm (w/d)</b>	634/518	440/420		440/420
<b>Shelf material</b>	wire shelves plastic-coated	wire shelves plastic-coated		wire shelves plastic-coated
<b>Shelf loading</b>	60 kg	45 kg		45 kg
<b>Evaporator cover</b>	–	yes		yes
<b>Handle</b>	ergonomic slimline handle	ergonomic slimline handle		ergonomic slimline handle
<b>Lock</b>	fitted	fitted		fitted
<b>Self-closing door</b>	yes	yes		yes
<b>Door hinges</b>	right, reversible on site	right, reversible on site		right, reversible on site
<b>Gross/net weight</b>	100/91 kg	89/82 kg		71/65 kg
<b>Accessories</b>				
Shelf, plastic-coated	7113485	7113333		7113333
Evaporator cover, white		9590241		9590241
Adjustable legs				9590231
RS 485/RS 232 adapter, data log software	9590387	9590387		9590387
Additional lock barrels (up to 10)		on request		on request
Foot pedal opener	9094502			
Roller bars		9590380		9590380

<sup>1</sup> Measured at +25°C ambient temperature and +5°C set temperature for fridges and -20°C for freezers

\* Gradient as defined in EN 60068-3: the difference between the warmest and coldest average measurements, increased by their expanded uncertainty, throughout the duration.

\*\* Max. fluctuation as per EN 60068-3: greatest fluctuation value determined throughout the duration of measurements.



Vaccine & Laboratory Refrigerators	LKUv 1613 MediLine	LKUv 1610 MediLine	Laboratory Fridge-Freezer Combo	LCv 4010 MediLine
<b>Total gross/net capacity</b>	152/143 litre	142/133 litre	<b>Total gross/net capacity</b> fridge compartment	254/240 litre
<b>Exterior dimensions in mm (w/d/h)</b>	597/615/820	597/615/820	<b>Total gross/net capacity</b> freezer compartment	107/105 litre
<b>Interior dimensions in mm (w/d/h)</b>	440/435/670	440/435/670	<b>Exterior dimensions in mm (w/d/h)</b>	597/615/2003
Energy consumption in 365 days <sup>1</sup>	369 kWh	273 kWh	<b>Interior dimensions in mm (w/d/h)</b> fridge compartment	440/441/1105
Ambient temperature range	+10°C to +35°C	+10°C to +35°C	<b>Interior dimensions in mm (w/d/h)</b> freezer compartment	433/435/597
Refrigerant	R 600a	R 600a	Energy consumption in 365 days <sup>1</sup>	657 kWh
Sound power level	47 dB(A)	47 dB(A)	Ambient temperature range	+10°C to +35°C
Voltage/Connection rating	220–240V~/1.0 A	220–240V~/1.0 A	Refrigerant	R 600a
Cooling system	forced-air	forced-air	Sound power level	52 dB(A)
Defrost	automatic	automatic	Voltage/Connection rating	220–240V~/1.5 A
Temperature range	+3°C to +16°C	+3°C to +16°C	Cooling system	fridge/freezer comp.
Gradient* / max. fluctuation**	5.1°C/4.9°C	4.3°C/4.6°C	Defrost	fridge/freezer comp.
External cabinet finish	steel/white	steel/white	Temperature range	fridge/freezer comp.
Door/lid material	glass door	steel	Gradient*	fridge/freezer comp.
Internal liner material	commercial grade moulded polystyrol	commercial grade moulded polystyrol	Max. fluctuation**	fridge/freezer comp.
Type of control	electronic controller	electronic controller	External cabinet finish	steel/white
Temperature display	external digital	external digital	Door/lid material	steel
Power failure alarm	when mains power return	when mains power return	Internal liner material	commercial grade moulded polystyrol
Fault: warning signal	visual and audible	visual and audible	Type of control	electronic controller
Interface/Volt-free alarm contact	RS 485/yes	RS 485/yes	Temperature display	external digital
Interior light	LED lighting, with separate switch		Power failure alarm	when mains power return
Adjustable shelves	3	3	Fault: warning signal	visual and audible
Usable shelf area in mm (w/d)	440/420	440/420	Interface/Volt-free alarm contact	RS 485/yes
Shelf material	wire shelves plastic-coated	wire shelves plastic-coated	Adjustable shelves	4
Shelf loading	45 kg	45 kg	Usable shelf area in mm (w/d)	440/409
Evaporator cover	yes	yes	Shelf material	wire shelves plastic-coated/evaporator plates
Handle	ergonomic slimline handle	ergonomic slimline handle	Shelf loading	45 kg/24 kg
Lock	fitted	fitted	Drawers	3
Self-closing door	yes	yes	Handle	ergonomic slimline handle
Door hinges	right, reversible on site	right, reversible on site	Lock	fitted
Gross/net weight	46/43 kg	39/36 kg	Self-closing door	yes
			Door hinges	right, reversible on site
			Gross/net weight	90/84 kg
<b>Accessories</b>				
Shelf, plastic-coated	7113333	7113333	<b>Accessories</b>	
Stacking kit, white	9592697	9592697	Shelf, plastic-coated, for	fridge compartment
Roller bars	9590521	9590521	Evaporator cover, white, for	fridge compartment
Evaporator cover, white	9590523	9590523	NTC product temperature sensor	
NTC product temperature sensor			RS 485/RS 232 adapter, data log software	
RS 485/RS 232 adapter, data log software	9590387	9590387	Roller bars	
Foot pedal opener			Additional lock barrels (up to 10)	
Additional lock barrels (up to 10)	on request	on request		

<sup>1</sup> Measured at +25°C ambient temperature and +5°C set temperature for fridges and -20°C for freezers

\* Gradient as defined in EN 60068-3: the difference between the warmest and coldest average measurements, increased by their expanded uncertainty, throughout the duration.  
 \*\* Max. fluctuation as per EN 60068-3: greatest fluctuation value determined throughout the duration of measurements.

# The advantages at a glance



The laboratory appliances are equipped with a **volt-free alarm contact** for forwarding alarms to remote monitoring systems.



**Access port** allows for the integration of an independent temperature sensor. NTC spark-free product temperature sensors are available as an accessory for all spark-free refrigerators and freezers with electronic controller.



The **commercial grade moulded polystyrol inner liner** is easy to clean for optimal hygiene.



The refrigerators are equipped with **fully adjustable glass shelves** that can be removed when door is opened at 90°. Shelf loading capacity is up to 45kg.



Freezer compartment of the Spark-free Fridge-Freezer combination comes with drawers that can be easily removed using the recessed handles and are transparent for viewing contents.



The **precise electronic controller** allows temperature to be set to 1/10°C accuracy.



All laboratory refrigerators and freezers with **spark-free interior** are tested according to the 2014/34/EU (ATEX) Directive.



The electronic controller has a **data memory** that logs and stores min./max. temperature and last 3 alarm events for 41 days.



**1-point temperature calibration function** permits compensation between the set temperature and actual internal temperature when using an independent sensor for accurate temperature control.

**Self-closing door** at less than 60° prevents cold loss and contributes to temperature stability. **Physical lock** protects against unauthorised access and **keypad lock** prevents set temperature and alarm setting changes without passcode.



Door seals can be replaced.

# Quality right down to the smallest detail

Liebherr spark-free laboratory refrigerators and freezers are suitable for storing explosive and highly flammable substances. The interior meets the safety requirements of the EU Directive 2014/34/EU (ATEX) and have been tested according to EN 1127-1,

IEC 60079-0 and IEC 60079-15 standards by electrosuisse SEV (Swiss Association for Electrical Engineering, Power and Information Technologies), an approved ATEX conformity evaluation organisation.



### Certified according to ATEX.

Spark-free refrigerators and freezers are tested according to 2014/34/EU (ATEX) and rated II 3G Ex nA T6 making them suitable for storing explosives and highly flammable substances in sealed containers.



### Precise electronic controller.

The precise electronic controller with digital temperature display allows temperature to be set to 1/10°C accuracy and symbols in the display indicate operating status of appliance. The electronic controller has a flush-mounted and easy-to-use keypad interface.



### Accurate 1-point calibration.

1-point temperature calibration function permits compensation between the set temperature and actual internal temperature when using an independent sensor for accurate temperature control. Positive and negative changes to the correction value can be made in increments of 0.1K.



### External temperature and alarm documentation.

Alarms can be forwarded to remote monitoring systems using volt-free alarm contact, and RS 485 interface allows temperature data and alarms to be sent to building management systems. LTM monitoring software is available as an optional accessory.

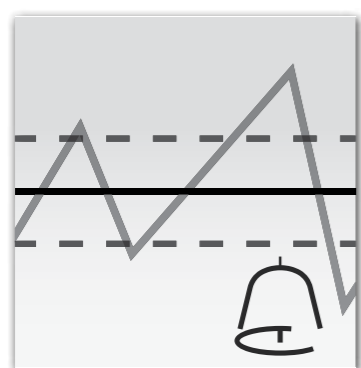

### Integrated alarm system.

Audible and visual alarms alert users to temperature breaches and when door is ajar for more than 1 minute. All alarm parameters can be individually set. For example, the door-open alarm delay can be adjusted between 1 and 5 minutes. A visual signal will appear when mains power returns after power outage.



### Integrated data memory.

The electronic controller is equipped with an integrated data memory that logs minimum and maximum internal temperature as well as the last three alarm events and power failure, by time, date and duration. Alarm parameters are set as a difference of  $\pm 3^\circ\text{C}$  from set temperature and can be adjusted if required by users.

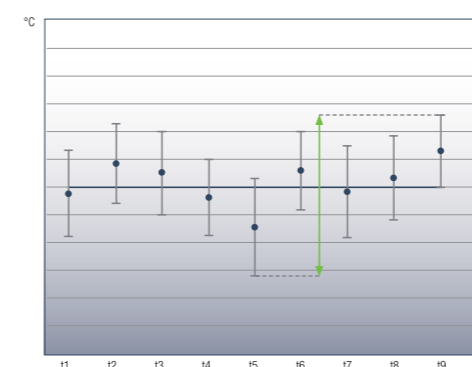

### Maximum temperature stability and consistency.

Temperature stability and consistency is maintained in the refrigerators by the forced-air cooling system working in conjunction with the routing of air flow, and by the static cooling system in the freezers. Designed according to EN 60068-3 for maximum temperature stability and consistency.



### Sturdy glass shelves.

The refrigerators are equipped with fully adjustable glass shelves that can be removed when door is opened at 90°. Shelf loading capacity is 40kg. The freezers come with plastic drawers which sit on evaporator plates for optimal temperature control and consistent cooling. Loading capacity of each drawer is 24kg.



**Spark-free Laboratory Fridge-Freezer Combo**

with electronic controller

<b>Total gross/net capacity</b>	fridge compartment	254/240 litre
<b>Total gross/net capacity</b>	freezer compartment	107/105 litre
<b>Exterior dimensions in mm (w/d/h)</b>		597/615/2003
<b>Interior dimensions in mm (w/d/h)</b>	fridge compartment	440/441/1105
<b>Interior dimensions in mm (w/d/h)</b>	freezer compartment	433/433/597
Energy consumption in 365 days <sup>1</sup>		657 kWh
Ambient temperature range		+10°C to +35°C
Refrigerant		R 600a
Sound power level		52 dB(A)
Voltage/Connection rating		220–240V~/1.5 A
Cooling system	fridge/freezer comp.	forced-air/static
Defrost	fridge/freezer comp.	automatic/manual
Temperature range	fridge/freezer comp.	+3°C to +16°C / –9°C to –30°C
Gradient*	fridge/freezer comp.	4.0°C/7.9°C
Max. fluctuation**	fridge/freezer comp.	3.9°C/5.5°C
External cabinet finish		steel/white
Door/lid material		steel
Internal liner material		commercial grade moulded polystyrol
Type of control		electronic controller
Temperature display		external digital
Power failure alarm		when mains power return
Fault: warning signal		visual and audible
Interface/Volt-free alarm contact		RS 485/yes
Adjustable shelves	fridge compartment	4
Usable shelf area in mm (w/d)	fridge compartment	440/409
Shelf material	fridge/freezer comp.	glass/glass
Shelf loading	fridge/freezer comp.	45 kg/24 kg
Drawers	freezer compartment	3
Handle		ergonomic slimline handle
Lock/Self-closing door		fitted/yes
Door hinges		right, reversible on site
Gross/net weight		93/87 kg
<b>Accessories</b>		
Glass shelf		9293629
NTC product temperature sensor		9590145
RS 485/RS 232 adapter, data log software		9590387
Roller bars		9592756
Additional lock barrels (up to 10)		on request

**LCexv 4010** MediLine

**Spark-free Laboratory Refrigerators and Freezers**

with electronic controller

<b>Total gross/net capacity</b>		360/344 litre
<b>Exterior dimensions in mm (w/d/h)</b>		597/615/1840
<b>Interior dimensions in mm (w/d/h)</b>		440/435/1635
Energy consumption in 365 days <sup>1</sup>		316 kWh
Ambient temperature range		+10°C to +35°C
Refrigerant		R 600a
Sound power level		48 dB(A)
Voltage/Connection rating		220–240V~/1.5 A
Cooling system/Defrost		forced-air/automatic
Temperature range		+3°C to +16°C
Gradient*/max. fluctuation**		5.5°C/5.1°C
External cabinet finish		steel/white
Door/lid material		steel
Internal liner material		commercial grade moulded polystyrol
Type of control		electronic controller
Temperature display		external digital
Power failure alarm		when mains power return
Fault: warning signal		visual and audible
Interface/Volt-free alarm contact		RS 485/yes
Adjustable shelves		5
Usable shelf area in mm (w/d)		440/420
Shelf material		glass
Shelf loading		40 kg
Drawers/Number of baskets		–/–
Compartment height in mm		–/–
Handle		ergonomic slimline handle
Lock/Self-closing door		fitted/yes
Door hinges		right, reversible on site
Gross/net weight		74/68 kg
<b>Accessories</b>		
Glass shelf		9293629
Stacking kit, white		9592697
Roller bars		9590521
Evaporator cover, white		9590523
Adjustable legs		9590231
NTC product temperature sensor		9590231
RS 485/RS 232 adapter, data log software		9590145
Additional lock barrels (up to 10)		9590387

<sup>1</sup> Measured at +25°C ambient temperature and +5°C set temperature for fridges and -20°C for freezers



**LKexv 3910** MediLine

**LKUexv 1610** MediLine

**LGex 3410** MediLine

**LGUex 1500** MediLine

360/344 litre	141/130 litre	310/284 litre	139/129 litre
597/615/1840	597/615/820	597/615/1840	597/615/820
440/435/1635	440/435/670	420/400/1587	454/450/663
316 kWh	315 kWh	478 kWh	338 kWh
+10°C to +35°C	+10°C to +35°C	+10°C to +35°C	+10°C to +35°C
R 600a	R 600a	R 600a	R 600a
48 dB(A)	47 dB(A)	45 dB(A)	45 dB(A)
220–240V~/1.5 A	220–240V~/1.0 A	220–240V~/1.5 A	220–240V~/1.0 A
forced-air/automatic	forced-air/automatic	static/manual	static/manual
+3°C to +16°C	+3°C to +16°C	–9°C to –30°C	–9°C to –26°C
5.5°C/5.1°C	3.9°C/4.8°C	6.9°C/4.2°C	6.6°C/3.3°C
steel/white	steel/white	steel/white	steel/white
steel	steel	steel	steel
commercial grade moulded polystyrol	commercial grade moulded polystyrol	commercial grade moulded polystyrol	commercial grade moulded polystyrol
electronic controller	electronic controller	electronic controller	electronic controller
external digital	external digital	external digital	external digital
when mains power return	when mains power return	when mains power return	when mains power return
visual and audible	visual and audible	visual and audible	visual and audible
RS 485/yes	RS 485/yes	RS 485/yes	RS 485/yes
5	3		
440/420	440/420	420/400	454/450
glass	glass	evaporator plates	evaporator plates
40 kg	40 kg	24 kg	24 kg
–/–	–/–	8/–	3/1
		185	149
ergonomic slimline handle	ergonomic slimline handle	ergonomic slimline handle	ergonomic slimline handle
fitted/yes	fitted/yes	fitted/yes	fitted/yes
right, reversible on site	right, reversible on site	right, reversible on site	right, reversible on site
74/68 kg	41/38 kg	91/86 kg	45/42 kg
9293629	9293629		
	9592697		9592697
9590380	9590521	9592756	9590521
9590241	9590523		
9590231		9590231	
		9590145	
9590387	9590387	9590387	9590387
on request	on request	on request	on request

\* Gradient as defined in EN 60068-3: the difference between the warmest and coldest average measurements, increased by their expanded uncertainty, throughout the duration.  
 \*\* Max. fluctuation as per EN 60068-3: greatest fluctuation value determined throughout the duration of measurements.



# The advantages at a glance

# Quality right down to the smallest detail



The LKexv models are **labelled** clearly and permanently on the **outer housing** in accordance with the ATEX Directive 2014/34/EU, including **information for cleaning**.



The **commercial grade moulded polystyrol inner liner** is easy to clean for optimal hygiene.



Equipped with **fully adjustable glass shelves** that can be removed when door is opened at 90°. Shelf loading capacity is 40kg.



Fitted with a **physical lock** to protect against unauthorised access.



**Sealed defrost water drain** in LKexv models complies with ATEX Directive 2014/34/EU.



**Reversible door hinges** in the LKexv models enable individual adaption to space conditions. The door seals can also be easily replaced as required.



### Certified according to ATEX.

The LKexv models are labelled clearly and permanently on the outer housing in accordance with the ATEX Directive 2014/34/EU, including information for cleaning. Rated as II 3G Ex nA II T6, these appliances are suitable for storing explosive and highly flammable substances in sealed containers.

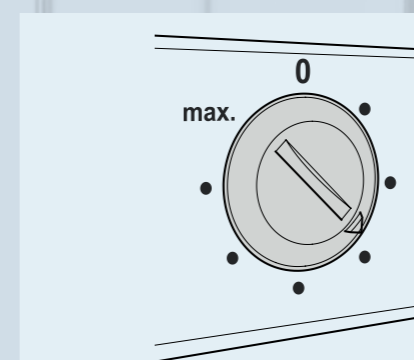

### Mechanical dial controller.

The LKexv models are factory set to +5°C and designed for optimal temperature stability and consistency according to EN 60068-3. Temperature can be set between 0 and max (+15°C) using the mechanical or dial control with selected temperature shown on the external digital display.



### Hygienic interior for versatile use.

The commercial-grade moulded polystyrol inner liner is exceptionally easy to clean and enables optimum hygiene. The moulded trayslides prevent the glass shelves from tipping and allow them to be varied in height.

### Glass shelves.

The glass shelves ensure secure storage even for small items and have a loading capacity of up to 40 kg.



### Water tray.

The defrost water drain in the LKexv models is sealed for compliance to ATEX Directive 2014/34/EU. The defrost water from an automatic defrost cycle is collected in the tray and must be manually emptied at regular intervals.



**Spark-free Laboratory Refrigerators**

with mechanical (dial) control

**LKexv 5400** MediLine

**LKexv 3600** MediLine

**Spark-free Laboratory Refrigerators**

with mechanical (dial) control

**LKexv 2600** MediLine

<b>Total gross/net capacity</b>	554/520 litre	333/307 litre	<b>Total gross/net capacity</b>	240/221 litre
<b>Exterior dimensions in mm (w/d/h)</b>	750/730/1640	600/610/1640	<b>Exterior dimensions in mm (w/d/h)</b>	600/610/1250
<b>Interior dimensions in mm (w/d/h)</b>	600/560/1452	470/440/1452	<b>Interior dimensions in mm (w/d/h)</b>	470/440/1062
Energy consumption in 365 days <sup>1</sup>	359 kWh	346 kWh	Energy consumption in 365 days <sup>1</sup>	287 kWh
Ambient temperature range	+10°C to +40°C	+10°C to +40°C	Ambient temperature range	+10°C to +40°C
Refrigerant	R 600a	R 600a	Refrigerant	R 600a
Sound power level	48 dB(A)	48 dB(A)	Sound power level	48 dB(A)
Voltage/Connection rating	220–240V~/1.5 A	220–240V~/1.5 A	Voltage/Connection rating	220–240V~/1.0 A
Cooling system	forced-air	forced-air	Cooling system	forced-air
Defrost	automatic	automatic	Defrost	automatic
Temperature range	+1°C to +15°C	+1°C to +15°C	Temperature range	+1°C to +15°C
Gradient*/max. fluctuation**	6.9°C/5.8°C	4.8°C/3.0°C	Gradient*/max. fluctuation**	6.4°C/5.5°C
External cabinet finish	steel/white	steel/white	External cabinet finish	steel/white
Door/lid material	steel	steel	Door/lid material	steel
Internal liner material	commercial grade moulded polystyrol	commercial grade moulded polystyrol	Internal liner material	commercial grade moulded polystyrol
Type of control	analogue control	analogue control	Type of control	analogue control
Temperature display	external digital	external digital	Temperature display	external digital
Adjustable shelves	5	5	Adjustable shelves	4
Usable shelf area in mm (w/d)	600/550	470/425	Usable shelf area in mm (w/d)	470/425
Shelf material	glass	glass	Shelf material	glass
Shelf loading	40 kg	40 kg	Shelf loading	40 kg
Handle	ergonomic slimline handle	ergonomic slimline handle	Handle	ergonomic slimline handle
Lock	fitted	fitted	Lock	fitted
Door hinges	right, reversible on site	right, reversible on site	Door hinges	right, reversible on site
Gross/net weight	84/77 kg	64/59 kg	Gross/net weight	53/49 kg
<b>Accessories</b>			<b>Accessories</b>	
Glass shelf	9293613	9293615	Glass shelf	9293615
Castor base	9086365	9086323	Castor base	9086323
Adjustable legs	9590229	9590231	Adjustable legs	9590231
Additional lock barrels (up to 10)	on request	on request	Additional lock barrels (up to 10)	on request

<sup>1</sup> Measured at +25°C ambient temperature and +5°C set temperature

\* Gradient as defined in EN 60068-3: the difference between the warmest and coldest average measurements, increased by their expanded uncertainty, throughout the duration.

\*\* Max. fluctuation as per EN 60068-3: greatest fluctuation value determined throughout the duration of measurements.

# The advantages at a glance



**Audible and visual alarms** alert users of temperature breaches. Minimum and maximum temperature as well as last 3 alarm events are logged and stored in the **integrated data memory** of the electronic controller.

Alarms can be forwarded to remote monitoring systems using **volt-free alarm contact**.

The Low Temperature Chest Freezers are **factory set to -45°C** with temperature shown on external digital display.

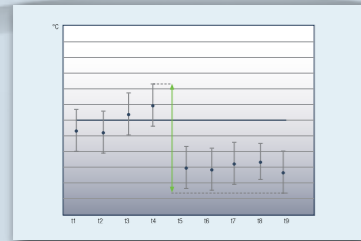

The Low Chest Freezers have a **static cooling system** for accurate temperature control and are designed according to EN 60068-3 for maximum temperature stability and consistency.

## Stop Frost

**StopFrost** system reduces frosting within the freezer thereby eliminating the need to manually defrost freezer. The state-of-the-art vacuum system allows the lid to be opened with ease immediately after lid has been closed for user convenience.



**One-piece steel lid** is sturdy and white coated aluminum inner material is easy to clean.

**Aluminum handle and robust hinges** of the lid allows for more than 50,000 door openings. A **physical lock** to protect against unauthorised access.



An **energy-efficient LED interior light** integrated in door lid switches on when opened to view contents of chest freezer.



Equipped with a **10mm access port** allows for the integration of an independent temperature sensor. NTC temperature sensors are available as an optional accessory.



**1-point temperature calibration function** allows precise temperature control when independent temperature sensor is connected to electronic controller.

# Quality right down to the smallest detail

Low Temperature Chest Freezers are a suitable option for laboratories looking for an inexpensive mid- to long-term cold

storage solution. Available in three sizes to accommodate space in any lab.



#### External temperature and alarm documentation.

Alarms can be forwarded to remote monitoring systems using volt-free alarm contact, and RS 485 interface allows temperature data and alarms to be sent to building management systems.



#### Precise electronic controller.

The precise electronic controller with digital temperature display allows temperature to be set accurately and symbols in the display indicate operating status of appliance. The electronic controller has a flush-mounted and easy-to-use keypad interface.



#### Accurate 1-point calibration.

1-point temperature calibration function permits compensation between the set temperature and actual internal temperature when using an independent sensor for accurate temperature control. Positive and negative changes to the correction value can be made in increments of 0.1K.



#### StopFrost System.

**StopFrost** system reduces frosting within the freezer thereby eliminating the need to manually defrost freezer. The state-of-the-art vacuum system allows the lid to be opened with ease immediately after lid has been closed for user convenience.



#### Integrated alarm system.

Alarm parameters are set as a difference of  $\pm 3^{\circ}\text{C}$  from set temperature and can be adjusted if required by users. Visual and audible alarms alert users of temperature breaches or when door is ajar for more than 1 minute. A visual signal will appear when mains power returns after power outage.



#### Integrated data memory.

The electronic controller is equipped with an integrated data memory that logs minimum and maximum internal temperature as well as the last three alarm events and power failure, by time, date and duration.



#### External temperature sensor.

10mm access port allows an independent temperature sensor to be connected for temperature monitoring.

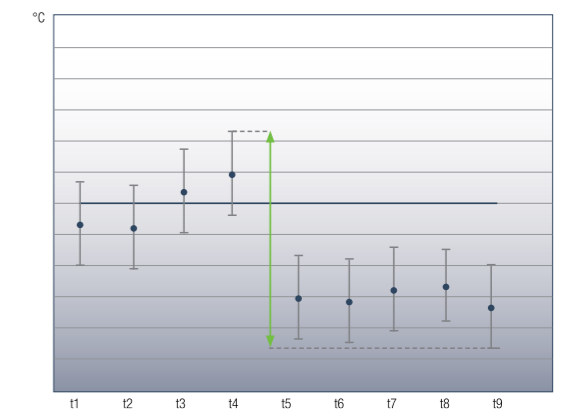

#### Maximum temperature consistency.

The static cooling ensures a stable and uniform temperature. The Low Temperature Chest Freezers are designed to EN 60068-3 for maximum temperature stability and consistency.



**Low Temperature Chest Freezers**

**LGT 4725** MediLine

LED

**LGT 3725** MediLine

LED

**LGT 2325** MediLine

LED

<b>Total gross / net capacity</b>	441 / 418 litre	350 / 332 litre	215 / 201 litre
<b>Exterior dimensions in mm (w/d/h)</b>	1653 / 789 / 915	1378 / 789 / 915	1138 / 740 / 915
<b>Interior dimensions in mm (w/d/h)</b>	1445 / 500 / 650	1170 / 500 / 650	889 / 410 / 630
Energy consumption in 365 days <sup>1</sup>	1589 kWh	1069 kWh	824 kWh
Ambient temperature range	+10°C to +30°C	+10°C to +30°C	+10°C to +30°C
Refrigerant	R 290	R 290	R 290
Sound power level	55 dB(A)	55 dB(A)	55 dB(A)
Voltage / Connection rating	220–240V~ / 3.5 A	220–240V~ / 3.0 A	220–240V~ / 2.0 A
Cooling system	static	static	static
Defrost	manual	manual	manual
Temperature range	–10°C to –45°C	–10°C to –45°C	–10°C to –45°C
Gradient* / max. fluctuation**	3.5°C / 1.8°C	4.3°C / 2.2°C	4.7°C / 1.9°C
External cabinet finish	steel / white	steel / white	steel / white
Door / lid material	steel	steel	steel
Internal liner material	white coated aluminium	white coated aluminium	white coated aluminium
Type of control	electronic controller	electronic controller	electronic controller
Temperature display	external digital	external digital	external digital
Power failure alarm	when mains power return	when mains power return	when mains power return
Interface / Volt-free alarm contact	RS 485 / yes	RS 485 / yes	RS 485 / yes
Insulation	100 mm	100 mm	120 mm
Number of baskets, max	16	13	10
Interior light	LED	LED	LED
Handle	profiled aluminium	profiled aluminium	profiled aluminium
Lock	fitted	fitted	fitted
Gross / net weight	89 / 77 kg	80 / 68 kg	68 / 58 kg
<b>Accessories</b>			
NTC product temperature sensor			
RS 485 / RS 232 adapter, data log software	9590407	9590407	9590407
Basket large 479×208×190 mm	9590387	9590387	9590387
Basket small 385×202×195 mm	7113627	7113627	7112317

<sup>1</sup> Measured at +25°C ambient temperature and –45°C set temperature

\* Gradient as defined in EN 60068-3: the difference between the warmest and coldest average measurements, increased by their expanded uncertainty, throughout the duration.

\*\* Max. fluctuation as per EN 60068-3: greatest fluctuation value determined throughout the duration of measurements.



## Accessories

### Section: Superior Performance Refrigerators and Freezers

#### Side-by-side set

The side-by-side set is easy to fit and enables the convenient use of two or more appliances next to one another and also allows their arrangement in a visually appealing manner. Furthermore, the side-by-side set prevents condensation and ice formation between two appliances which, without the side-by-side set, would otherwise be positioned next to one another.



#### U-shaped trayslides and plastic-coated shelves

Additional U-shaped trayslides and plastic-coated grid shelves can be retrofitted as required to provide extra storage options. The sturdy grid shelves have an extremely high loading capacity of up to 60 kg.

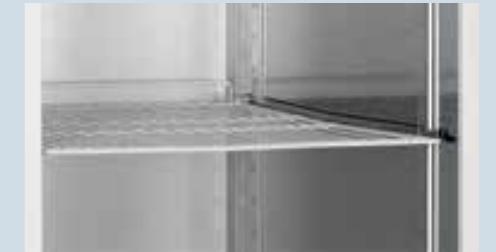

#### Interface converter with monitoring software

A special interface converter including the Liebherr LTM monitoring software is available for central documentation of the temperature profile data and alarm events of multiple appliances via the RS 485 serial interface. It is possible to network as many as 20 laboratory appliances and centrally document their parameters. Alarm forwarding or regular status reports to up to three email addresses can be configured as an additional feature. Alternatively, commercially available converters can be used to connect the appliances to a PC via WLAN or LAN. Software requirements: PC with Windows® operating system.



#### NTC product temperature sensor

An NTC product temperature sensor for logging product temperatures is available as a retrofit kit for the laboratory appliances with electronic controller. The logged product temperatures can either be read by the electronic controller or transferred to an external documentation system via the existing RS 485 interface.



#### Foot-pedal door opener

The optional foot-pedal opener is useful when you don't have a hand free.



### Section: Vaccine & Laboratory Refrigerators and Fridge-Freezer Combo

#### Interface converter with monitoring software

A special interface converter including LTM monitoring software is available for central documentation of the temperature profile data and alarm events of multiple appliances via the RS 485 serial interface. Capability is provided for interconnecting as many as 20 laboratory appliances and centrally documenting their parameters. Alarm forwarding or regular status reports to up to three email addresses can be configured as an additional feature. Alternatively, commercially available converters can be used to connect the appliances to a PC via WLAN or LAN. Software requirements: PC with Windows® operating system.



## Accessories

### Section: Vaccine & Laboratory Refrigerators and Fridge-Freezer Combo

#### NTC product temperature sensor

An NTC product temperature sensor for logging product temperatures is available as a retrofit kit for the laboratory appliances with electronic controller. The logged product temperatures can either be read by the electronic controller or transferred to an external documentation system via the existing RS 485 interface.



#### Additional lock barrels

Up to 10 additional lock barrels to protect the stored products against unauthorised access are available as accessories for the laboratory appliances with electronic controller. In case of multiple appliances, different locks can be installed to ensure that the respective appliance can only be accessed by the staff members responsible for it.



#### Stacking kit

A stacking kit is available as an accessory for combining the LKUv 1613, LKUv 1610, LKUxv 1610 and LGUex 1500 models as desired. This allows stacking a glass door appliance and solid door appliance or a refrigerator and freezer on a small footprint. In order to guarantee optimum stability, roller sets must not be fitted to appliances which are installed using a connecting frame. This is only permitted for individual appliances.



#### Evaporator cover

An evaporator cover can be installed for added safety, to ensure that cold-sensitive products cannot touch the evaporator.



#### Foot-pedal door opener

The optional foot-pedal opener is useful when you don't have a hand free.



#### Roller bars and adjustable legs

30 mm high roller sets can be retrofitted to the under-worktop LKUv models and height-adjustable legs can be retrofitted to the upright LKv models. The legs are adjustable between 115 mm and 170 mm in height.

In order to guarantee optimum stability, roller sets must not be fitted to appliances which are installed using a connecting frame. This is only permitted for individual appliances.



#### Shelves plastic-coated

Additional plastic-coated grid shelves can be retrofitted as required to provide extra storage options. The sturdy grid shelves have an extremely high loading capacity of up to 60 kg.



### Section: Spark-free Laboratory Refrigerators and Freezers

#### NTC spark-free product temperature sensor

An NTC product temperature sensor without metal sheath is available as a retrofit kit for registering product temperatures. The registering temperatures can either be read by the control system or transferred to an external documentation system via the RS 485 interface.



#### Interface converter with monitoring software

A special interface converter including LTM monitoring software is available for central documentation of the temperature profile data and alarm events of multiple appliances via the RS 485 serial interface. Capability is provided for interconnecting as many as 20 laboratory appliances and centrally documenting their parameters. Alarm forwarding or regular status reports to up to three email addresses can be configured as an additional feature. Commercially available converters can be used to connect the connected appliances to a PC via WLAN or LAN. Software requirements: PC with Windows® operating system.



#### Additional lock barrels

Up to 10 additional lock barrels to protect the stored products against unauthorised access are available as accessories for the laboratory appliances with electronic controller. In case of multiple appliances, different locks can be installed to ensure that the respective appliance can only be accessed by the staff members responsible for it.



#### Glass shelves

Additional glass shelves can be retrofitted to the LCxv, LKxv and LKUxv models as required to provide extra storage options. The glass shelves made of toughened safety glass meet the standards for spark-free refrigerators in accordance with ATEX and have a loading capacity of up to 40 kg.



#### Stacking kit

A stacking kit is available as an accessory for combining the LKUxv and LGUex models as well as other under-worktop models in the LKUv range. This allows stacking laboratory fridge-freezers on a small footprint.

In order to guarantee optimum stability, roller sets must not be fitted to appliances which are installed using a connecting frame. This is only permitted for individual appliances.



## Accessories

### Section: Spark-free Laboratory Refrigerators and Freezers

#### Roller bars and adjustable legs

30 mm high roller sets can be retrofitted to the under-worktop LKUxv models and height-adjustable legs can be retrofitted to the upright LKexv models. The legs are adjustable between 115 mm and 170 mm in height.

In order to guarantee optimum stability, roller sets must not be fitted to appliances which are installed using a connecting frame. This is only permitted for individual appliances.



#### Evaporator cover

An evaporator cover can be installed for added safety, to ensure that cold-sensitive products cannot touch the evaporator.

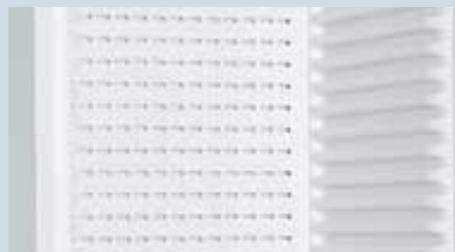

### Section: Spark-free Laboratory Refrigerators with mechanical (dial) control

#### Glass shelves

Additional glass shelves can be retrofitted to the LKexv models as required to provide extra storage options. The glass shelves made of toughened safety glass meet the standards for spark-free refrigerators in accordance with ATEX and have a loading capacity of up to 40 kg.



#### Castor base

A castor base is available as an accessory for the LKexv 5400, 3600 and 2600 models to allow flexible use of the appliances in different rooms.



#### Adjustable legs

Adjustable-height legs can be retrofitted to the LKexv 5400, 3600 and 2600 models for easy cleaning underneath. They are adjustable between 115 mm and 170 mm in height.



#### Additional lock barrels

Up to 10 additional lock barrels to protect the stored products against unauthorised access are available as accessories for the laboratory appliances. In case of multiple appliances, different locks can be installed to ensure that the respective appliance can only be accessed by the staff members responsible for it.



### Low Temperature Chest Freezers

#### NTC product temperature sensor

An NTC product temperature sensor for logging product temperatures is available as a retrofit kit for the laboratory chest freezers. The logged product temperatures can either be read by the electronic controller or transferred to an external documentation system via the existing RS 485 interface.



#### Interface converter with documentation software

A special interface converter including LTM documentation software is available for central documentation of the temperature profile data and alarm events of multiple appliances via the RS 485 serial interface. It is possible to network as many as 20 laboratory appliances and centrally monitor their parameters. Alarm forwarding or regular status reports to up to three email addresses can be configured as an additional feature. Commercially available converters can be used to connect the connected appliances to a PC via WLAN or LAN. Software requirements: PC with Windows® operating system.



#### Baskets

The optional baskets provide an optimum overview of the stored preparations and can help to improve the handling and organising of the freezer contents.





Liebherr commercial appliances can be found at specialist retailers where providing first-class service and expert advice is their top priority.

You will find an overview of other Liebherr appliances in our catalogue of fridges and freezers for professional use. Available in stores or on [home.liebherr.com.au](http://home.liebherr.com.au).



[home.liebherr.com.au](http://home.liebherr.com.au)



[www.enlake.com.au](http://www.enlake.com.au)

Ph: 1800 094 259

Whilst every effort is made to ensure all specifications and information in our brochure is correct at time of printing, Andi-Co Australia reserve the right to make changes without notification. Where actual appliance measurements, specifications and ratings are crucial we recommend that the actual appliance installation instructions that accompany each appliance be checked. Andi-Co Australia ABN 68 005 899 365 will not be liable for any loss arising from the information in this brochure, whether in negligence or otherwise. Images are for illustrative purposes only. Issue date: August 2019